



Play Snoot Round Adjustable

LedsC4 Team

Downlight Play Snoot Round Adjustable LED 8.5W LED warm-white 3000K CRI 92 27.3° PHASE CUT White IN IP20 / OUT IP54 649lm

Technical features

Luminaire total power: 8.5W
 Real lumens: 649
 Real lm/W: 76
 Correlated Colour Temperature (CCT): LED warm-white 3000K
 Lens / reflector angle: MEDIUM 27°
 UGR: <=16
 Structure material: Aluminium
 Structure finish: White
 Diffuser material: Methacrylate
 Diffuser finish: Transparent
 Driver Brand: TCI
 Voltage / frequency: 220-240V/50-60Hz
 Dimming protocol: PHASE CUT
 Power Factor: 0.96
 Useful life: 50,000h L80B20
 Warranty: 5 years

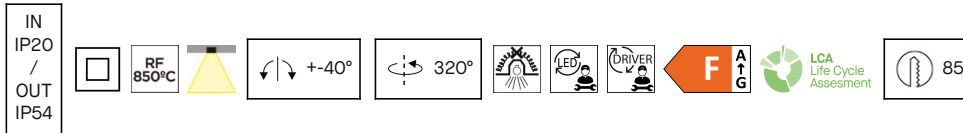

Luminotechnic features

Luminance C0°G65°: 2678
 Luminance C90°G65°: 2678
 CRI: 92
 MacAdam steps: 2
 Photobiological risk: RG1

UGR		Lampholder	Quantity	Light source power (W)	Correlated Colour Temperature (CCT)
S=0.250					
Ceiling / cavity	0.7	LED	1	6.4W	LED warm-white 3000K
Walls	0.5				
Working Plane	0.2				
Room dimensions	X=4H, Y=8H				
UGR crosswise	11.3				
UGR lengthwise	11.3				

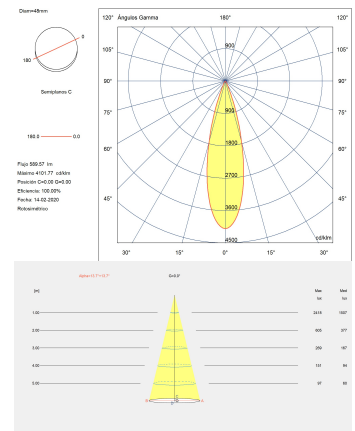
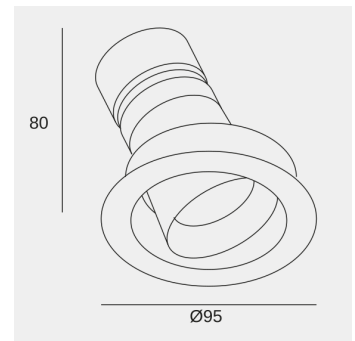

Image may not match reference. LedsC4 reserves the right to amend any of the product's components. The data related to flux, power and colour temperature may be subject to changes made by the manufacturer.



Play Snoot Round Adjustable

LedsC4 Team

Downlight Play Snoot Round Adjustable LED 8.5W LED warm-white 3000K CRI 92 27.3° PHASE CUT White IN IP20 / OUT IP54 649lm

Logistics

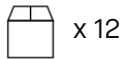

Net weight (kg): 0.26

Packaged weight (kg): 0.32

Packaging: 170mm x 120mm x 120mm

Image may not match reference. LedsC4 reserves the right to amend any of the product's components. The data related to flux, power and colour temperature may be subject to changes made by the manufacturer.



Play Snoot Round Adjustable

LedsC4 Team

Downlight Play Snoot Round Adjustable LED 8.5W LED warm-white 3000K CRI 92 27.3° PHASE CUT White IN IP20 / OUT IP54 649lm

Optional accessories



71-4754-14-00

White visual comfort

Structure material: Polycarbonate
Dimensions: 52 x NA x 27
Net weight (kg): 0.01



71-4754-60-00

Black visual comfort

Structure material: ABS
Dimensions: 52 x NA x 26
Net weight (kg): 0.01

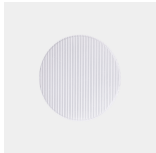

71-5167-00-00

5 x Elliptical diffuser

Structure material: Polycarbonate
Dimensions: NA x NA x NA
Net weight (kg): 0.01

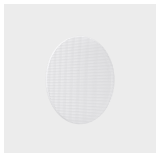

71-5658-00-00

5 x Square diffuser

Structure material: Polycarbonate
Dimensions: 47 x NA x 2
Net weight (kg): 0.08

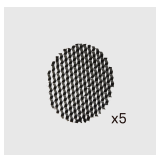

71-5166-60-00

5 x Honeycomb panel

Structure material: Aluminium
Dimensions: NA x NA x NA
Net weight (kg): 0.01

Image may not match reference. LedsC4 reserves the right to amend any of the product's components. The data related to flux, power and colour temperature may be subject to changes made by the manufacturer.

Optional accessories

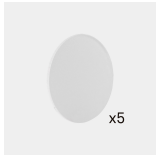

71-6099-00-00

5 x Halo diffuser

Structure material: Methacrylate

Dimensions: 47 x NA x 2

Net weight (kg): 0.01

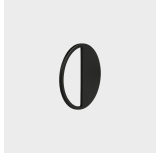

71-7895-60-00

5 x Screen

Structure material: Steel

Dimensions: 46 x NA x 2

Net weight (kg): 0.09

Image may not match reference. LedsC4 reserves the right to amend any of the product's components. The data related to flux, power and colour temperature may be subject to changes made by the manufacturer.