

THURSO ROUND

astro

GB

PLEASE READ THE INSTRUCTIONS CAREFULLY
BEFORE COMMENCING ASSEMBLY

Live: Normally Brown / Red
Neutral: Normally Blue / Black
Earth: Normally Green / Yellow

FR

LIRE ATTENTIVEMENT LES INSTRUCTIONS
AVANT DE COMMENCER LE MONTAGE

Phase: Normalement Brun / Rouge
Neutre: Normalement Bleu / Noir
Terre: Normalement Vert / Jaune

IT

LEGGERE ATTENTAMENTE LE ISTRUZIONI
PRIMA DI COMINCIARE L'ASSEMBLAGGIO

Cavo positivo: normalmente marrone o rosso
Cavo neutro: normalmente blu o nero
Cavo terra: normalmente verde o giallo

DE

LESEN SIE BITTE DIE ANWEISUNGEN
SORGFALTIG DURCH, BEVOR SIE MIT DEM
ZUSAMMENBAUEN BEGINNEN

Phase: Normalerweise Braun / Rot
Nulleiter: Normalerweise Blau / Schwarz
Erde: Normalerweise Grün / Gelb

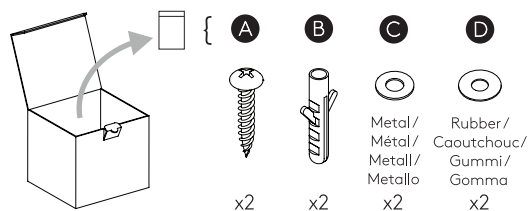
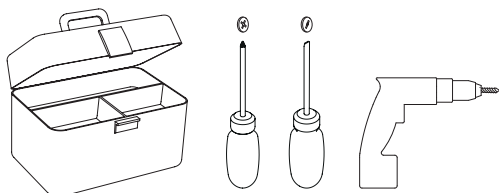
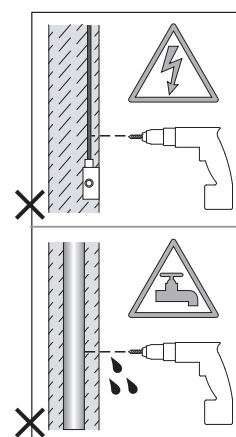

1

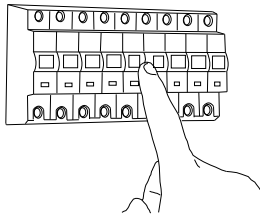

TURN OFF POWER

Couper Le Courant! / Spegner La Corrente! /
Strom Abhalten!

2

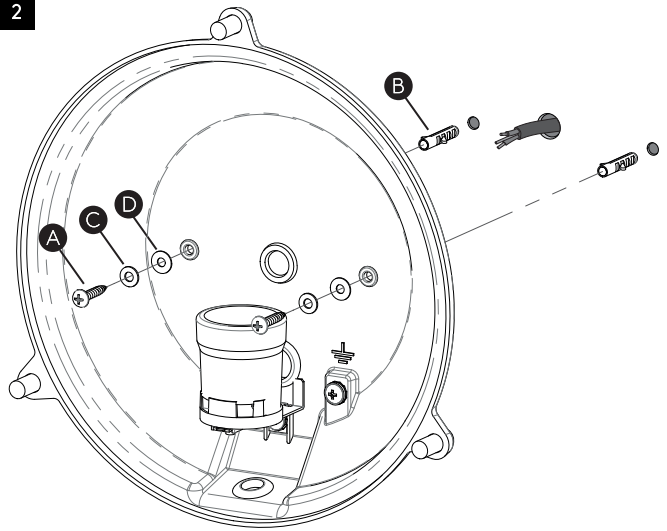

3

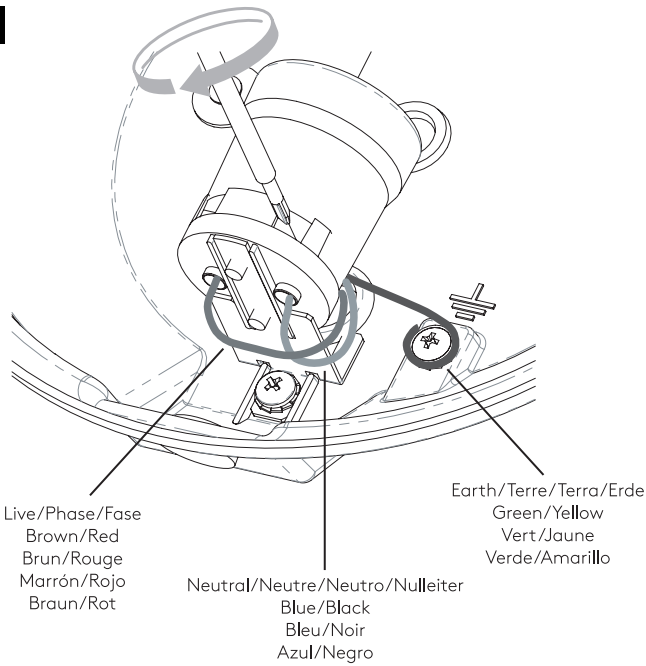

4

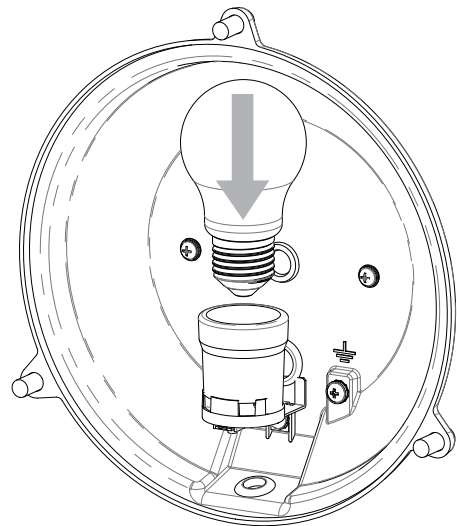

5

