



Technical Data

Batten Holders (T2)

Brief product description:

A complete range of high quality robust ceiling accessories, offering durability, reliability and ease of installation.

Back plate for use with 747 and 748.

Features:

- Backplate and skirt mouldings produced in satin finish urea
- 3 terminal T2 rated lampholder
- Knock outs around circumference to allow for surface wiring

Product Images



753

Technical Specifications

Standard(s)	BS EN 61184 (752, 753, 747, 748 Products)
Rating	2 Amp 250V~, 150 Watts Max (752, 753, 747, 748 Products)
Terminal Capacity	3 x 1.0mm ² 2 x 1.5mm ² (752, 753, 747, 748 Products)
	3 x 1.0mm ² 3 x 1.5mm ² (201E Products)
Covered by RoHS directive	Yes
Covered by WEEE directive	No
Size	75mm dia x 67mm (752 Products)
	75mm dia x 70.5mm (753 Products)
	64mm dia x 77mm (747 Products)
	64mm dia x 61mm (748 Products)
	82.5mm dia x 14.5mm (201E Products)
Fixing Centres	50.8 mm

Batten Holders (T2)

Packaging Information

Cat No.	Description	Packaging Type			Pack Quantity			Barcode		
		Product	Inner Box	Outer Box	Each	Inner Box	Outer Box	Individual	Inner Box	Outer Box
752	3T with Short Skirt	New BG Packing	New BG Packing	New BG Packing	1	10	100	/	5021166752096	5021166752089
753	3T with HO Skirt	New BG Packing	New BG Packing	New BG Packing	1	10	100	/	5021166753093	5021166753086
747	3T, HO Skirt, Angled	New BG Packing	New BG Packing	New BG Packing	1	10	100	/	5021166747092	5021166747085
748	3T, Short Skirt, Angled	New BG Packing	New BG Packing	New BG Packing	1	10	100	/	5021166748099	5021166748082
201E	Back Plate	/	B.W Strip Inner	B.W Strip Inner	1	20	200	/	5021166201099	5021166201082

Weights & Dimensions

Cat No.	Description	Dimension (W x L x H) cm			Weight (g)			CMB (m ³)
		Product	Inner Box	Outer Box	Each	Inner Box	Outer Box	Outer Box
752	3T with Short Skirt			27.8 x 33.5 x 30.3	116		5000	
753	3T with HO Skirt		13.6 x 30.2 x 6.6	14.8 x 32.6 x 7.6	94	128	4000	
747	3T, HO Skirt, Angled			24.6 x 40.4 x 27.8			692	
748	3T, Short Skirt, Angled			24.6 x 40.4 x 27.8			5000	
201E	Back Plate			24 x 43 x 17.5			5000	

Installation Information

Safety Warning

Before use please read carefully and use in accordance with these safety wiring instructions.

Before commencing any electrical work ensure the supply is **switched off at the mains**. Either by switching off the consumer unit or by removing the appropriate fuse.

Wiring should be in accordance with the latest edition of the IEE regulations (BS 7671).

Wire Identification – Twin & Earth Cable

EARTH = Green/Yellow Sleaving

NEUTRAL = Black (pre Apr 04) / Blue (after Apr 04)

LIVE = Red (pre Apr 04) / Brown (after Apr 04)



The ends of the individual conductors should have the insulation removed by approx. 10mm. Any bare earth conductors should be sleeved to within 10mm of the ends.

(These details are for general information only and conductor lengths may need to be trimmed in certain installations).

For lighting circuits, use sleeving of the appropriate 'live' colour to ensure clear identification of live connections. See diagram for typical lighting circuit wiring using 4-way junction box.

To prevent fire hazard always use cable of the correct rating and type.

Technical Helpline: 0845 194 7584
If in doubt consult a competent electrician.

General Installation Instructions

Switch off power supply at consumer unit and remove fuse from circuit.

IF USING THE NEW PRODUCT TO REPLACE AN OLD ONE

1. Release the retaining screws and support the product as you remove it from the wall or ceiling.
2. It is essential that the new product is wired up in the same way as the old one, with Earthing as stated in these instructions.
3. The simplest way is either to label each conductor with the location of the terminal to which it connects as you release it or to transfer one conductor at a time to the corresponding terminal on the new product. (Alternatively refer to the appropriate wiring diagrams for guidance)
4. Before refixing the new product, double check your connections ensuring that no wires are trapped. Do not over tighten the screws.
5. Once you are sure that all work has been completed correctly, replace the fuse for the circuit, switch the power back on, and test.

When Installing From New

1. To assist with the correct installation of this product please consult the appropriate wiring diagram. When connecting the new accessory ensure that only the bare end of the wire enters the terminal, and no bare wires are visible. Always tighten the terminal screws securely.
2. For ceiling roses feed the cable through the aperture in the base, increase entry size if necessary.
 - 2a. Securely screw the base unit to a ceiling joist or wall, as appropriate. Take care to avoid existing wiring or pipe work. When fitted correctly and using 0.75mm² 2 core circular cable, the ceiling rose is designed to carry fittings with a maximum weight of 3kg. Install the cables to the appropriate terminals.
 - 2b. To assist with the correct installation of this product please consult the appropriate wiring diagram of two typical installation methods.
 - 2c. Fit the cables around the cable restraints as shown in the illustration on page.
 - 2d. Screw the rose cover back into place.
3. Once you are sure that all work has been completed correctly, replace the fuse for the circuit, switch the power back on, and test. The product is now ready for use.

Batten Holders (T2)

Installation Information

Ceiling Switch – 1 Way

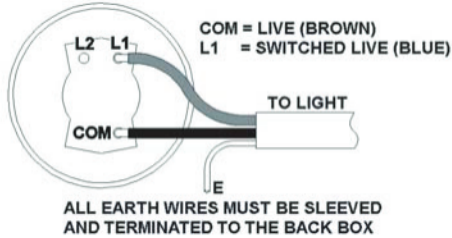

Ceiling Switch – 2 Way

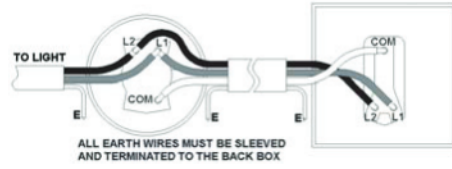

Batten Holders, Ceiling Rose & Pendant Sets

1) Looping Circuit

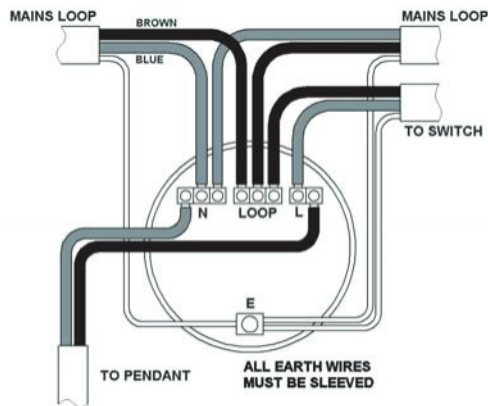

Batten Holders, Ceiling Rose & Pendant Sets

2) Junction Box Circuit

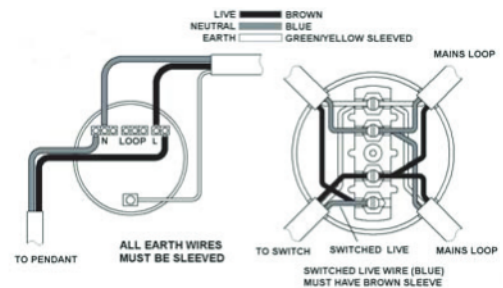

Batten Holders, Ceiling Rose & Pendant Sets (cont)

Cable Restraints

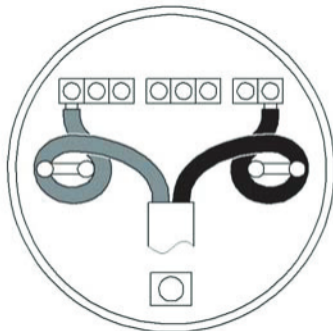

After wiring the ceiling rose & before fitting the cover, ensure both the wires to the pendant fitting are routed around the cable restraint posts as shown in diagram. This must be done to avoid the weight of the pendant & any lamp shade putting undue strain on the terminal connections.

45a Ceiling Switch

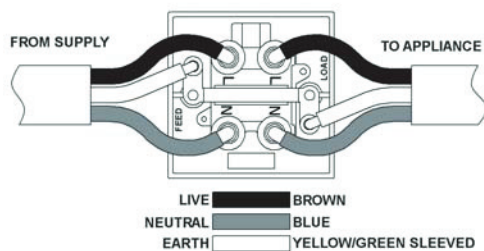

Pendant Lamp Holder

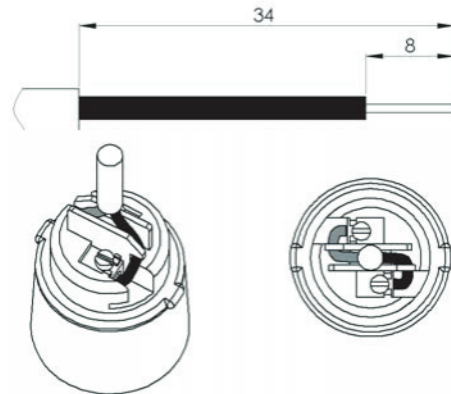

Low Energy Pendant – Shade Fitting

A 40mm shade conversion ring is included with the low energy lamp holder, which can be used to convert an existing 30mm lamp shade.

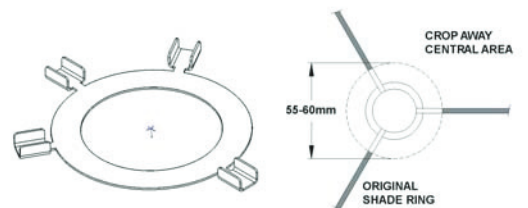

The conversion ring is designed to fit both 2-arm and 3-arm shades.

1) Remove the 30mm shade ring by cutting the support arms close to the central ring, as shown in diagram.

Batten Holders (T2)

Installation Information

Low Energy Pendant – Shade Fitting (cont)

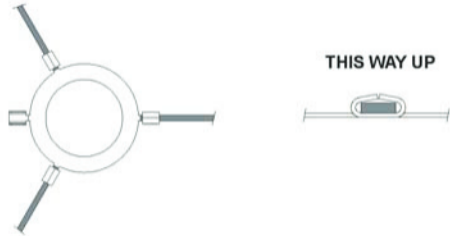

- 2) Fit the ends of the support arms into the appropriate tabs of the conversion ring. Note: it is important to fit the conversion ring under the support arms so that it takes the weight of the lampshade.
- 3) Tighten the metal tab firmly around each support arm using pliers.
- 4) Remove the spare tab if necessary.