

RADIO RECEIVER FOR 240V COMMANDS

Product code: WISEBOX Radio receiver for ON/OFF commands of 240Vac loads 10A max.
 Receiver for the remote control of 240V appliances up to a maximum resistive power of 2000W compatible with the TVLINK system.

Programmable relay functions: impulsive, ON/OFF or timed.

Attention: before using the product, read carefully information on paragraph 6 (Warning).

1 - CONNECTIONS

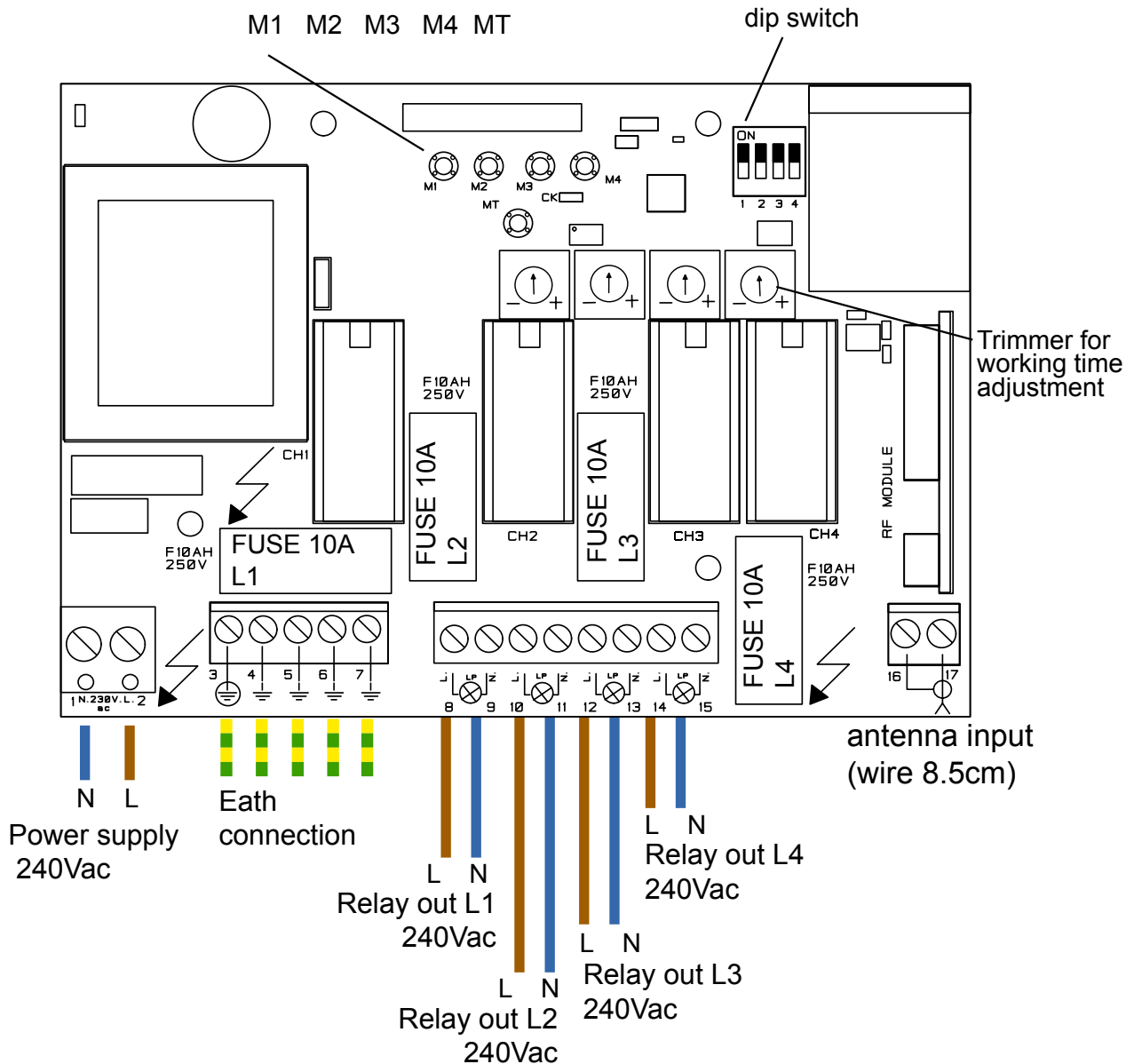

- DIP1 - ON L1 Relay with ON/OFF function
- OFF L1 Relay with impulsive function timeout 180ms
- DIP2 - ON L2 Relay with ON/OFF function
- OFF L2 Relay with impulsive function timeout 180ms
- DIP3 - ON L3 Relay with ON/OFF function
- OFF L3 Relay with impulsive function timeout 180ms
- DIP4 - ON L4 Relay with ON/OFF function
- OFF L4 Relay with impulsive function timeout 180ms

2 - TRANSMITTERS MEMORIZATION

The first transmitter can only be memorized using the receiver (you are advised to cancel the entire memory content at the beginning of each installation by pressing the MT button).

Each channel is associated with a button for the memorization:

M1 with relay L1, M2 with relay L2, M3 with relay L3, M4 with relay L4.

It's possible to memorize the same channel on different relays.

2.1 - MEMORIZATION SINGLE PUSH-BUTTON

The push-button will be memorised one by one with dynamic function On-Off-On-Off or impulsive.

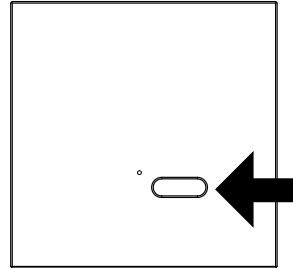
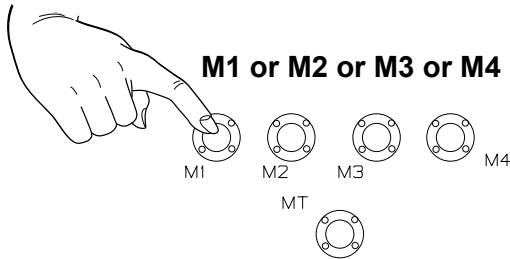

1- Press and hold down one of the push-button **M1** **o** **M2** **o** **M3** **o** **M4** of the receiver, the buzzer will make a beep each time and then sound continuously.

2- During the sound press the push-button which has to be memorised; the memorization is indicated by the intermittently sound of the buzzer.

2.2 - MEMORIZATION COUPLE OF PUSH-BUTTON

The channels CH1-CH2, CH3-CH4, CH6-CH7 will be memorised in couple with following function:

CH1: On CH3: On CH6: On
CH2: Off CH4: Off CH7: Off

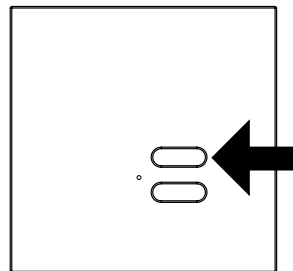
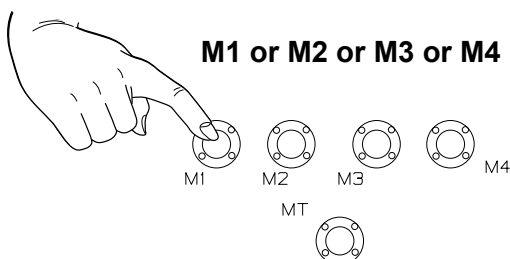

Use transmitters with at least 2 push-buttons.

In transmitters with 3, 6 and 7 push-buttons, push-button CH5 does not memorize.

1- Press **twice** and hold down one of the push-button **M1** **or** **M2** **or** **M3** **or** **M4** of the receiver, the buzzer will make a beep each time and then sound continuously.

2- During the sound press one of the couple of channel which is to be memorised; the memorization is indicated by the intermittently sound of the buzzer.

2.3 - MEMORIZATION OF GROUP COMMAND (ONLY COUPLE PUSH-BUTTON MEMORIZATION)

The channels CH1-CH2, CH3-CH4, CH6-CH7 will be memorised in couple with following function:

CH1: On CH3: On CH6: On in all output with setted the on/of function (dip ON)
CH2: Off CH4: Off CH7: Off

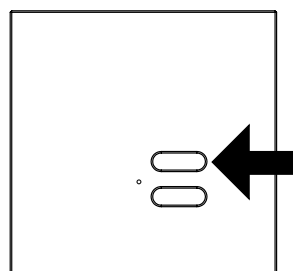
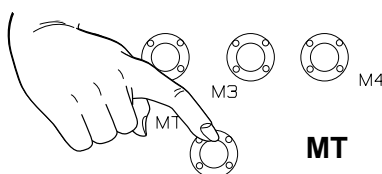

Use transmitters with at least 2 push-buttons.

In transmitters with 3, 6 and 7 push-buttons, push-button CH5 does not memorize.

1- Press and hold down the push-button **MT** of the receiver, the buzzer will make a beep each time and then sound continuously.

2- During the sound press one of the couple of channel which is to be memorised; the memorization is indicated by the intermittently sound of the buzzer.

2.4 - MEMORIZATION SINGLE TIMER CONTROLLED PUSH-BUTTON

The push-button will be memorised one by one with timer controlled function.

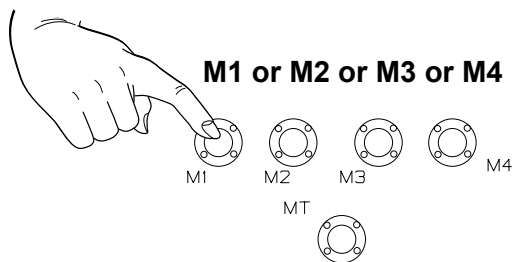

1- Press **three times** and hold down one of the push-button **M1 o M2 o M3 o M4** of the receiver, the buzzer will make a beep each time and then sound continuously.

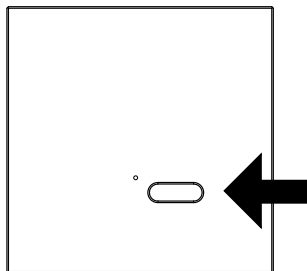

2- During the sound press the push-button which has to be memorised; the memorization is indicated by the intermittently sound of the buzzer.

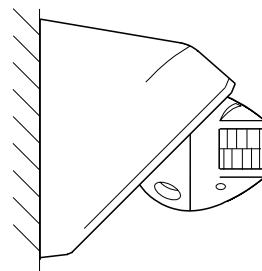

Use this type of memorization for the motion sensor. Memorize the ON command. The timer is managed by the receiver.

Adjust the value of the timer:
from 5sec. to 15min.

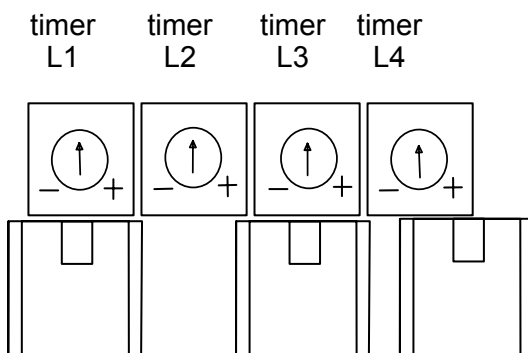

Every time that a radio command is received the timer starts to count the time.

2.5 - TO COPY A FUNCTION OF TRANSMITTER PUSH-BUTTON TO A NEW TRANSMITTER

The new transmitter will have the same functions as the transmitter used for the memorization.

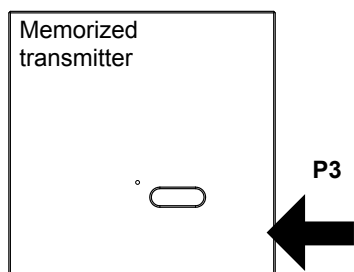

1- Press the button **P3** located inside the **already memorized transmitter**. The enabled receiver sounds continuously.

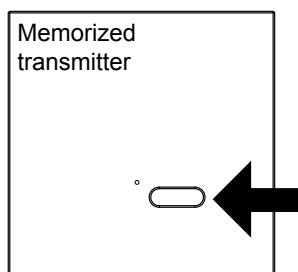

2- Within 5 seconds press a push-button of the **already memorized transmitter** from which the function has to be copied. The buzzer will interrupt the sound for 1 sec., and then will carry on for 5 seconds.

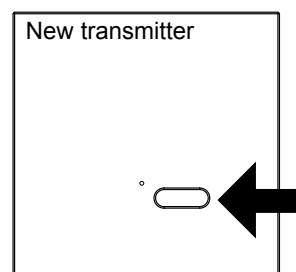

3- During the sound press the push-button of the **new transmitter** which has to be memorised; the memorization is indicated by the intermittently sound of the buzzer.

3 - TO DELETE A TRANSMITTER FROM RECEIVER

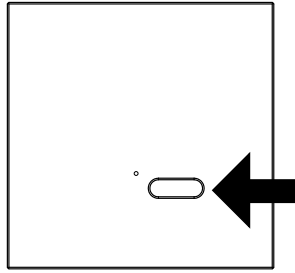
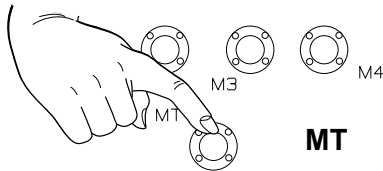

1- Press **twice** and hold down the push-button **MT** of the receiver, the buzzer will make a beep each time and then sound intermittently and slowly.

2- During the intermittent sound press the push button which is to be deleted; the deletion is indicated by the continuously sound of the buzzer.

3.1 - TO DELETE A TRANSMITTER FROM TRANSMITTER

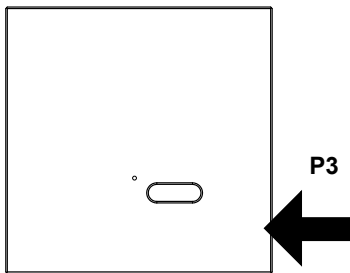

1- Press **three times** the button **P3** placed inside of the transmitter. Buzzer will sound intermittently and slowly.

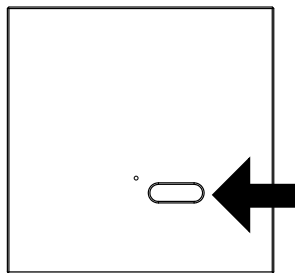

2- During the intermittent sound press the push button which is to be deleted; the deletion is indicated by the continuously sound of the buzzer.

3.2 - TO DELETE ALL TRANSMITTER

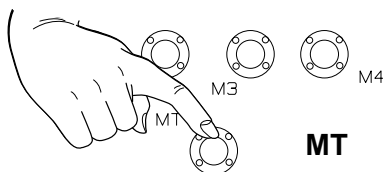

1- Press **three times** the button **MT** and hold down. The buzzer will make a beep each time and then will sound intermittently and rapidly.
2- Hold down the push-button for 10 seconds; after that the buzzer will sound continuously indicating that the memory has been cancelled.

4 - ERRORS DURING THE MEMORISING OR DELETING

If the code hasn't been memorised it could be due to the following reasons:

- the code already exists in memory.
- the memory is full.
- the indexing procedure has not been correctly started up.

If the code hasn't been cancelled it could be due to the following reasons:

- the code doesn't exist in memory.

Memory full or empty

If the memory of the receiver is full or empty the buzzer will sound three times either during the memorization phase or after the reset of the receiver.

5 - TECHNICAL SPECIFICATIONS

-Power supply 240 V ~
-Relay out 10A 240 V ~ $\cos \varphi 1$
4000W total maximum load *

* The sum of the loads on the 4 outputs can not exceed 4000W
The product is characterized by outputs with 5A slow blow fuse protection. Verify, according to the applied load on each output, if its value is correct or if it should be replaced with a different value.

The connection cables must have a section suitable to the maximum load applied to the output.

- Inrush current 120A
- Reception frequency 868.3 MHz
- Intermediate frequency 10.7 MHz
- Sensitivity (finely tuned signal) 1 μ V
- Operating temperature range $-20^{\circ} \div +50^{\circ}\text{C}$

-The maximum number of transmitters that can be memorized is 42.

Dimension:

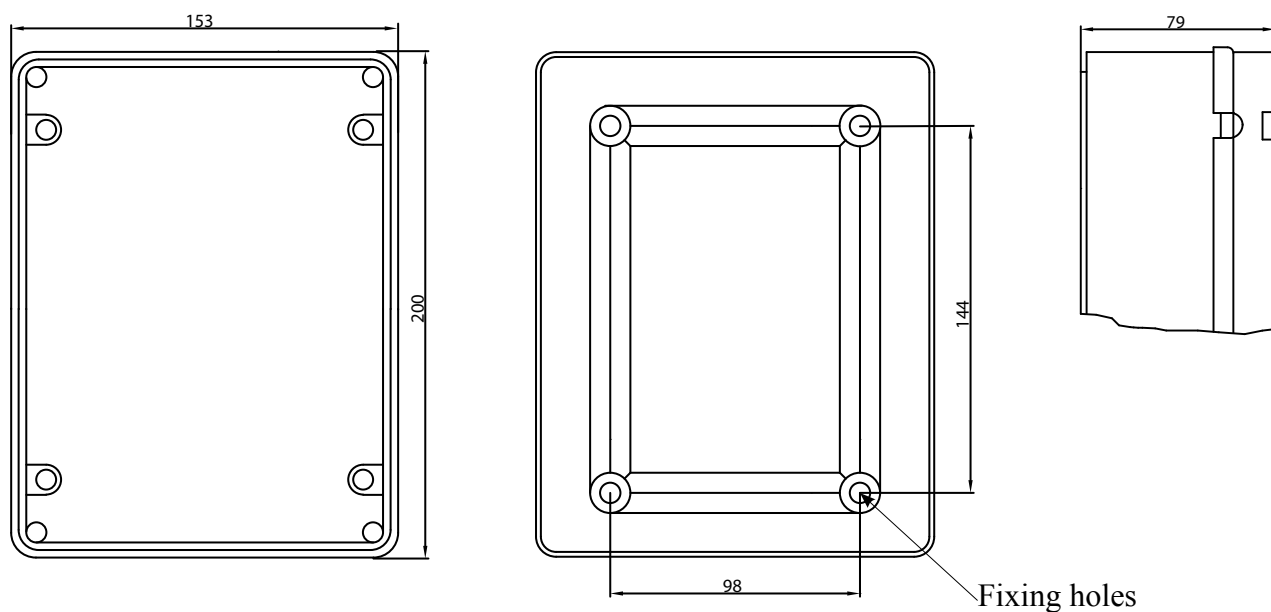



The subject appliance must be installed only by qualified technical personnel in compliance with the standards. All connections must be rated for a single-phase power supply of 240V. For the disconnection from the power line, use an all-pole switch with contact with an opening of at least 3,5mm. Only suitable materials for the connections must be used to guarantee insulation that complies with current standards on the subject of electrical safety. The receiver only carries out ON/OFF commands and all safety devices required by the system must be prepared a part.

Ground connection must be provided separately.

In the connection to power line and to outputs follow the indications of line and neutral.

Connections wire must have a section suitable to the applied load.

In the view of a constant development of their products, the manufacturer reserves the right for changing technical data and features without prior notice.

The appliance is not intended for use by people (including children) with reduced physical, sensorial or mental facilities, or with a lack of experience or knowledge, unless they are supervised by a person responsible for their safety or instruction concerning the use of the appliance. Children must be supervised to ensure that they do not play with the appliance.

Must necessarily be fitted the cable glants provided or the cable glants with the same mechanical and safety characteristics.

The power cable must have a nominal characteristic of 90 ° C temperature T.

The main power supply must have connecting cables with a cross section suitable for the load applied to the relays.

The connecting cables of the main power supply and of the loads must have adequate section and electrical isolation; their installation must comply with the standards on electrical systems.

The following table shows (roughly) the typical values of maximum resistance for km and maximum tolerable current of a copper electrical wire, according to its section:

Section (mm ²)	R (ohm/Km)	Max. current (A)
1	19.5	5
1.5	13.3	10
2.5	7.98	16
4	4.95	26
6	3.30	32

If the power cable is damaged, it must be replaced by the manufacturer or by the technical assistance service or by a similarly qualified person, in order to avoid all the risks. Use the appliance only with loads in which the functioning isn't dangerous in the case that they remain permanently activated.

The device's signal reception could be disturbed by several factors such as:

- the presence of electrical frequency noise being transmitted by other appliances working in the same environment and on the same frequency.
- appliances installed in metal containers or shielded from metal parts; only use containers made of plastic.

The manufacturer, Teleco Automation s.r.l, declares that the type of radio equipment is compliant with Directive 2014/53/EU. The full text of the EU compliance declaration is available at the following Internet address: www.telecoautomation.com/ce.

INFORMATION TO USERS under art. 14 of the 2012/19/EU DIRECTIVE OF THE EUROPEAN PARLIAMENT AND COUNCIL of 4 July 2012 on waste electrical and electronic equipment (WEEE). The crossed bin symbol on the equipment, or its packaging, indicates that the product must be collected separately from other waste at the end of its useful life and not with mixed urban waste. Please contact your municipality, or local authority, for all information regarding the waste sorting systems available in the area. The retailer is obliged to collect the old equipment free-of-charge when the customer buys a new equivalent equipment. This is to encourage correct recycling/disposal. Appropriate waste sorting for the subsequent recycling, treatment and disposal in an environmentally sound way of the disused equipment avoids negative effects on the environment or human health and favours the re-use or recycling of the equipment's materials.

In the view of a constant development of their products, the manufacturer reserves the right for changing technical data and features without prior notice.