



Wi-Fi interface, App-programmable, to remotely radio control all devices from Smartphones.

## SIMPLE INSTRUCTION

Product code:

# TVDAY868A01

### Features

- Available in 868.3MHz frequency.
- Easy access via Wi-Fi or mobile network from any compatible device.
- Up to 50 programmable device commands.
- Possibility to create scenarios.
- Weekly timer to send commands at a specific date and time.



Wi-Fi

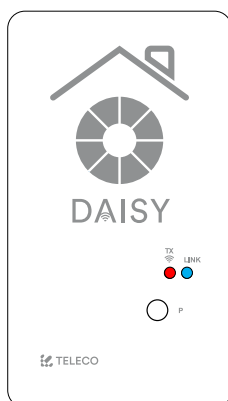

DAISY BOX

868.3MHz



868.3MHz



\* The Blue Series receivers are bidirectional. They can receive and execute commands and send the status back to **DAISY BOX**

## WISE CONTROLS APP

### 1.0 Characteristics

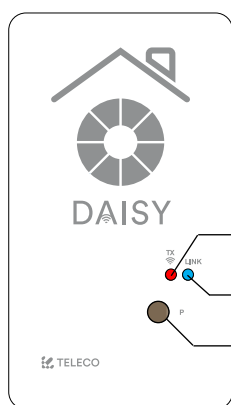

**LED:** Radio commands Transmission

**LED:** Wi-Fi Network

**Button:** Reset Wi-Fi Network configuration (\*)

\* The memorized transmitters are not deleted.

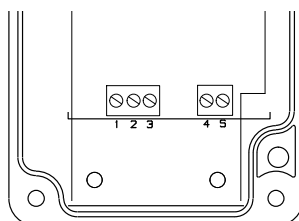

1. +12 ÷ 24Vdc
2. GND (-)
3. +5Vdc
4. COMMON
5. N.O. CONTACT INPUT

### Thermoplastic ABS

Not suitable for direct UV exposure

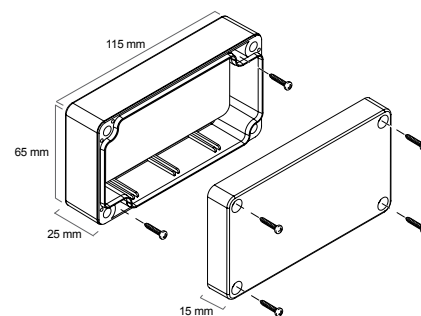

The product guarantees **IP54** rating if properly assembled.

### 1.1 Technical specification

- Transmission frequency	868.3 MHz (TVDAY868A01)	- Max. possible virtual transmitters	50
- Power supply	5 / 12 ÷ 24Vdc	- Protection	IP54
- Operating temperature range	-20° ÷ +50°C	- Material of the box and its cover	Thermoplastic ABS
		- Network Wi-Fi module	802.11 b/g/n
		- Frequency band	2.4GHz

TVDAY868A01\_MR

DOC.: T804.01\_EN

DATE:11/04/19

## 2.0 Installation

Download the app Wise Controls from App Store or Google Play. Check the compatibility with your device first. Once downloaded, it is possible to use it in DEMO mode, even without any DAISY BOX paired.



 In order to connect Daisy BOX to the WiFi network the router doesn't have filter blocks. In case of connection issues please contact the system administrator.

## 3.0 Registration

The smartphone must be connected to an internet network. Follow the procedure here below described:

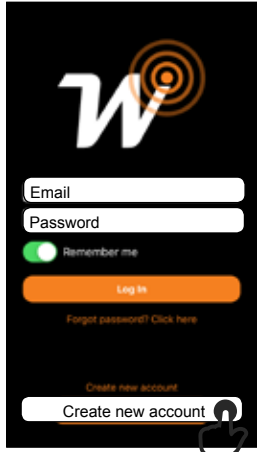

1. Tap on "Create new account".

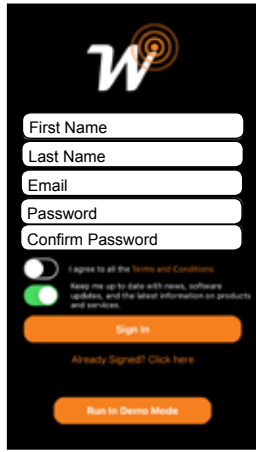

2. Fill the fields with the information required.



3. Once filled the fields tap on "Sign In".

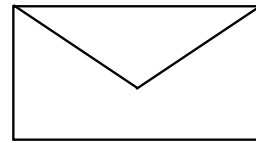

4. Check email to confirm registration.



5. "Log In" with User and PWD assigned.

## 4.0 First configuration with Android device

**Mandatory: Android version 4.4 KitKat or later.**



1. Run the Daisy APP

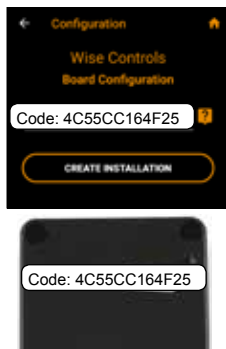

2. Fill the field with the **Code** written on the Daisy box label

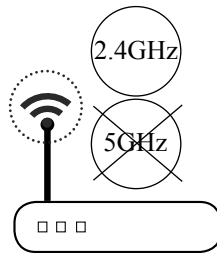

**Name:** Orange\_WiFi\_Network  
**Password:** 12345678

3. Take note of WiFi **Name** and **Password**.



4. Select your WiFi network.

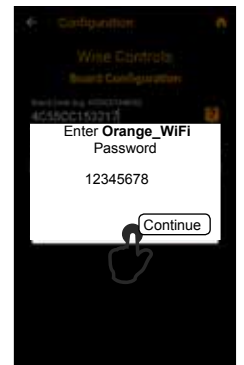

5. Enter Home Network's Password and tap "Continue"

**Warning: Verify that the option to connect to networks without Internet access is enabled in the phone.**

## 4.1 First configuration with IOS device

**Mandatory: IOS version 12.0 or later.**



1. On your phone, set up the Daisy\_4C55xx WiFi network and run the Daisy App.



2. Tap on "Create first Installation".

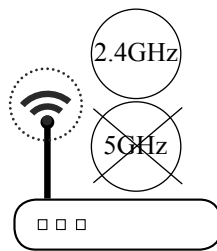

**Name:** Orange\_WiFi\_Network  
**Password:** 12345678

3. Take note of WiFi **Name** and **Password**.



4. Select your WiFi network.

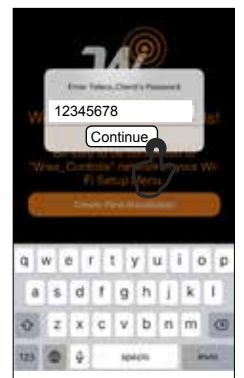

5. Enter Home Network's Password and tap "Continue"

## 5.0 Led indications

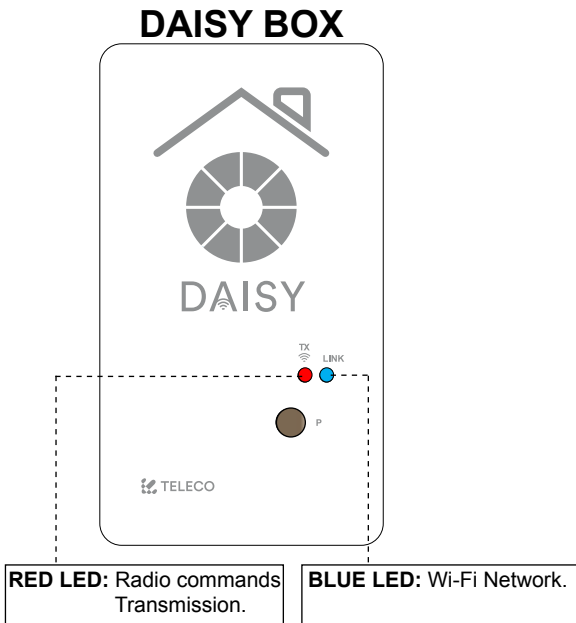

Transmission	<b>TX (RED LED): Radio commands</b>
<b>Active</b>	<b>ON</b>
<b>Not Active</b>	<b>OFF</b>
Status Wi-Fi connection	<b>LINK: Wi-Fi Network</b>
<b>Waiting for connection</b>	<b>Blue</b> <b>Blue</b> <b>Blue</b> ... 1 s ... 1 s ...
<b>Connecting</b>	<b>Blue</b> <b>Red</b> <b>Blue</b> <b>Red</b> <b>Blue</b> <b>Red</b> ... 0.5 s ... 0.5 s ... 0.5 s ...
<b>Connecting</b>	<b>Blue</b> <b>Blue</b> <b>Blue</b> ... 0.5 s ... 0.5 s ...
<b>Connected</b>	<b>Blue</b> <b>ON</b>

## 6.0 Main menu

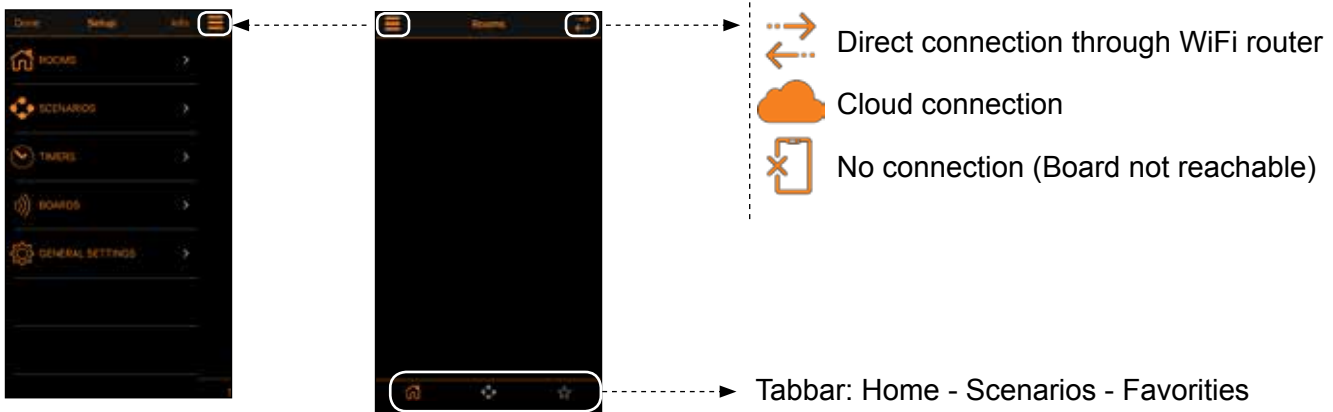

## 6.1 Setup rooms

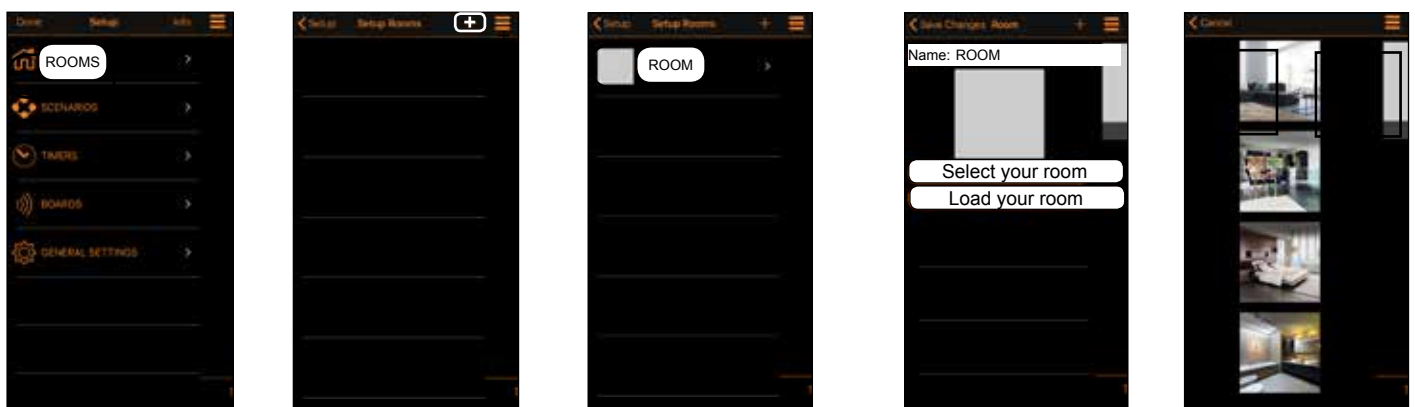

1. Create new rooms accessing the menu "Rooms" in Setup.

2. Tap (+) to add a room.

3. Tap (Room) to enter in the next menu.

4. Set the name and assign a picture amongst the 6 provided (Select your room) or select a picture of your device gallery.



**Note:** swipe a listed room left to delete it.

## 6.2 Adding commands to a room

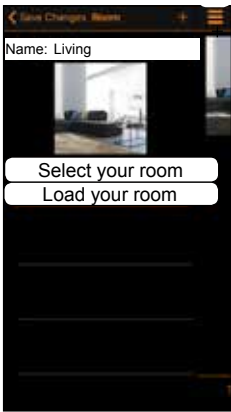

1. Tap "+" to add remote commands. Select the type of controlled device from the list.



2. Tap the transmitter to add.

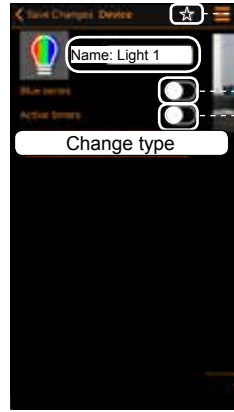

3. Assign a "Name".

----- Add to Favourites

----- Enable if the receiver is Blue Series

----- Enable to set the timers

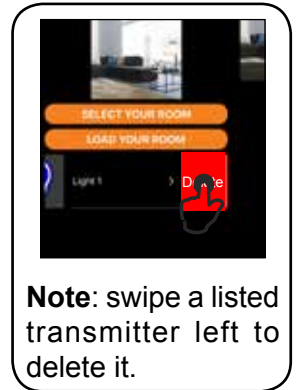

**Note:** swipe a listed transmitter left to delete it.

## 7.0 Scenarios

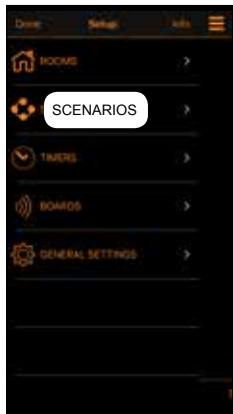

1. Create new scenarios accessing the menu "Scenarios" in Setup.

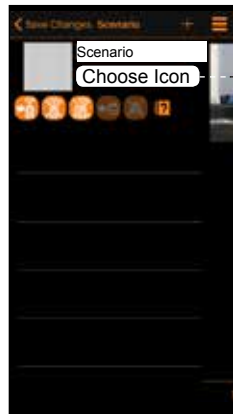

2. Tap "+" to add a scenario. Set the Name and assign an icon amongst the 9 provided.

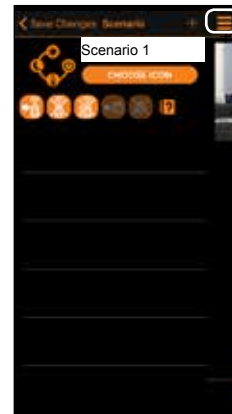

3. Tap "+" to add remote commands from any room.



4. Select the type of controlled device from the list.



5. Tap (Light 1) to add the first command.



6. Tap (GREEN) to chose the command the (OK).



7. The first device configured for the scenario appears on the display.



8. Repeat steps 3-4-5 to add the other devices to the scenario.

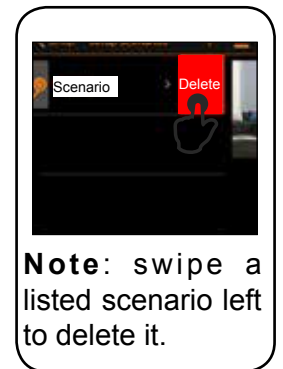

**Note:** swipe a listed scenario left to delete it.

## 7.1 Advanced scenario programming

Once the scenario has been completed, it's possible to assign it to a transmitter button or to a wired N.O. button connected to the input 4-5.

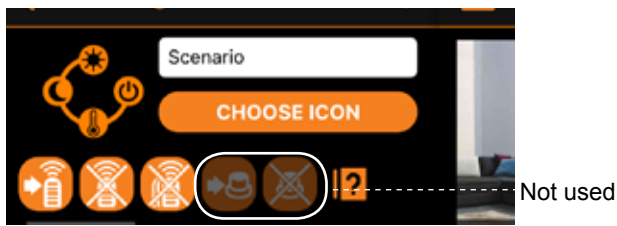

- Tap to delete all the associated transmitter buttons.
- Tap and press the transmitter button to delete.
- Tap and press the transmitter button to assign.

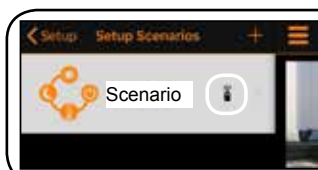
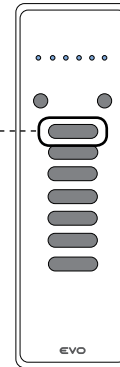

**Note:** When transmitters or the wired input are programmed, this icon is ON

## 8.0 Timers

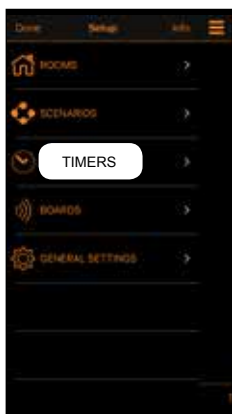

1. Create new timer accessing the menu "Timers" in Setup.

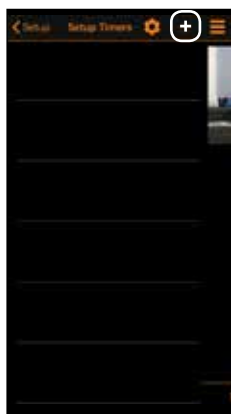

2. Tap "+" to add a timer.



3. Tap "Light 1" to add a timer.

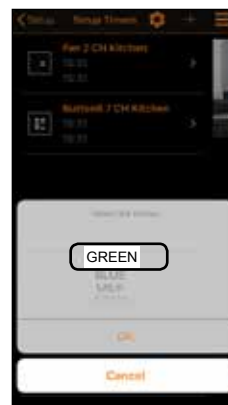

4. Tap (GREEN) to chose the command

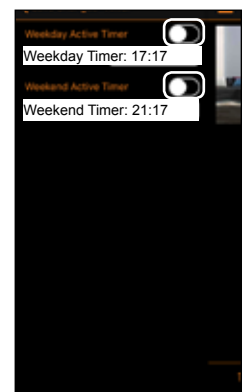

5. Enable the timers. Set the hour for the timers.

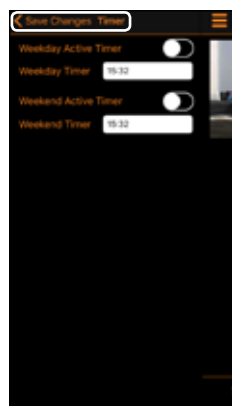

6. Tap "Save Changes".

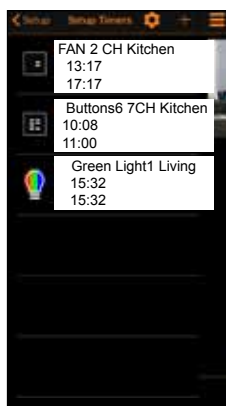

7. Repeat steps 2 and 3 to add timers to the other devices.



**Note:** swipe a listed timer left to delete it.

**Note:** To operate the timers must be enabled following the procedure described below:



1. Tap gear icon.



2. Tap (Active all timers) to enable the timers.

Enable timers



3. It's possible to set weekdays-weekend group. Tap on the day names to add in weekdays groups.

## 9.0 Select Boards

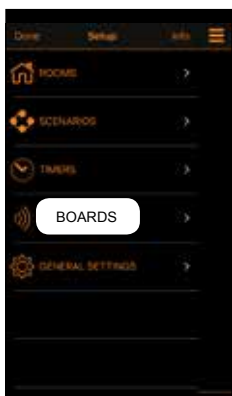

1. Tap (Boards) to enter in the next menu.

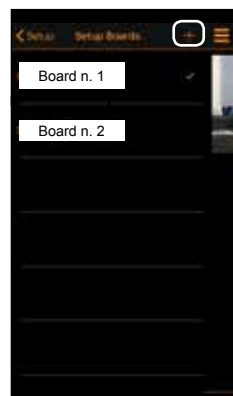

2. Tap the chosen board. To add new board tap (+).

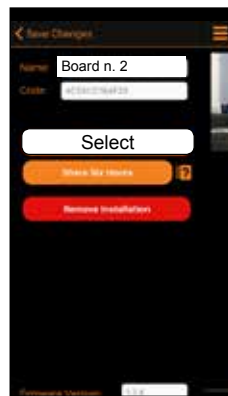

3. To pair the board tap (Select).

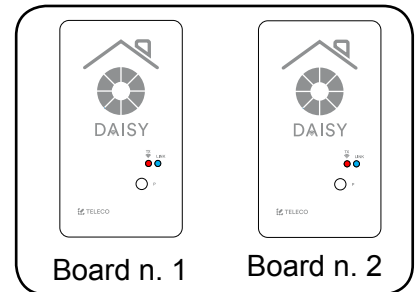

## 11.0 Share installation (SIX HOURS)

**Note:** Before starting, it is necessary to carry out the **Registration** procedure on the new smartphone described in the paragraph 3.0

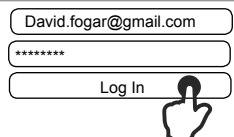

### Configured smartphone



1. Tap (Share installation).

### Configured smartphone

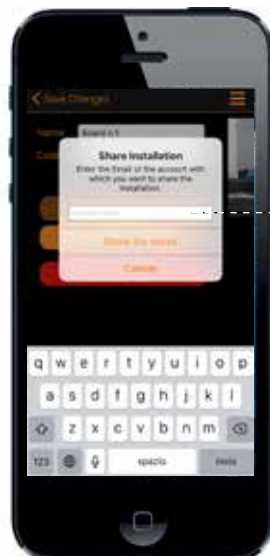

2. Fill the field with the email of the new smartphone. Tap (Share ...) installation.

### New smartphone

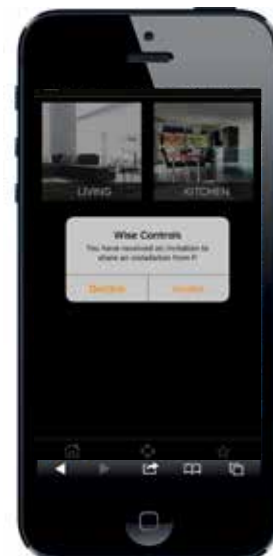

3. Accept the invite to share the installation.

## 12.0 General Setting

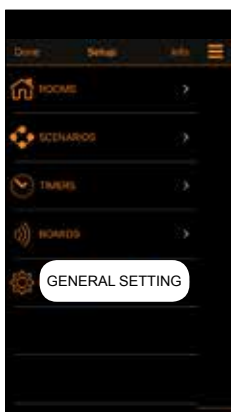

1. Tap (General Setting) to enter in the next menu.

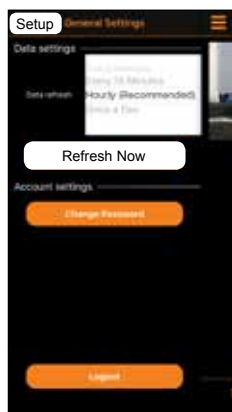

2. Choose the Refresh time and tap (Setup). In alternative tap (Refresh Now).

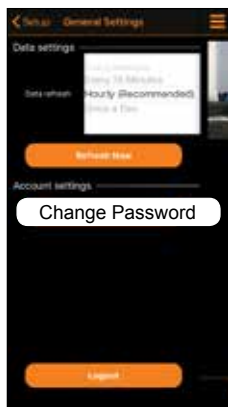

3. In order to set a new password tap (Change Password).



## 13.0 Info page

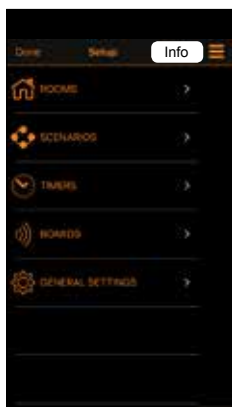

1. Tap (Info) to enter in the next menu.

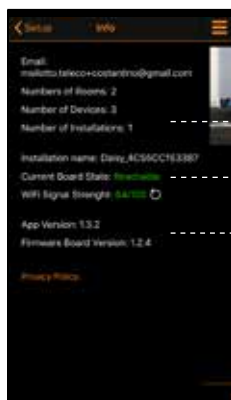

General configuration information

Status information of Daisy board

Software and firmware information

## 14.0 Home Page

Once configured the rooms with the transmitters tap (done) to enter in the (Home) page.

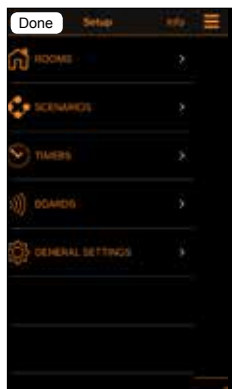

Setup Menu

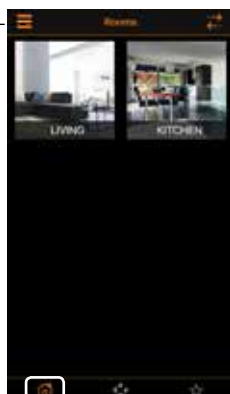

Rooms set

Favourites transmitters set  
Scenario set

## 14.1 Wise transmitter

**Note:** To operate the **Daisy transmitters** must be memorized in the receivers. See par. 14.2 and par. 14.3

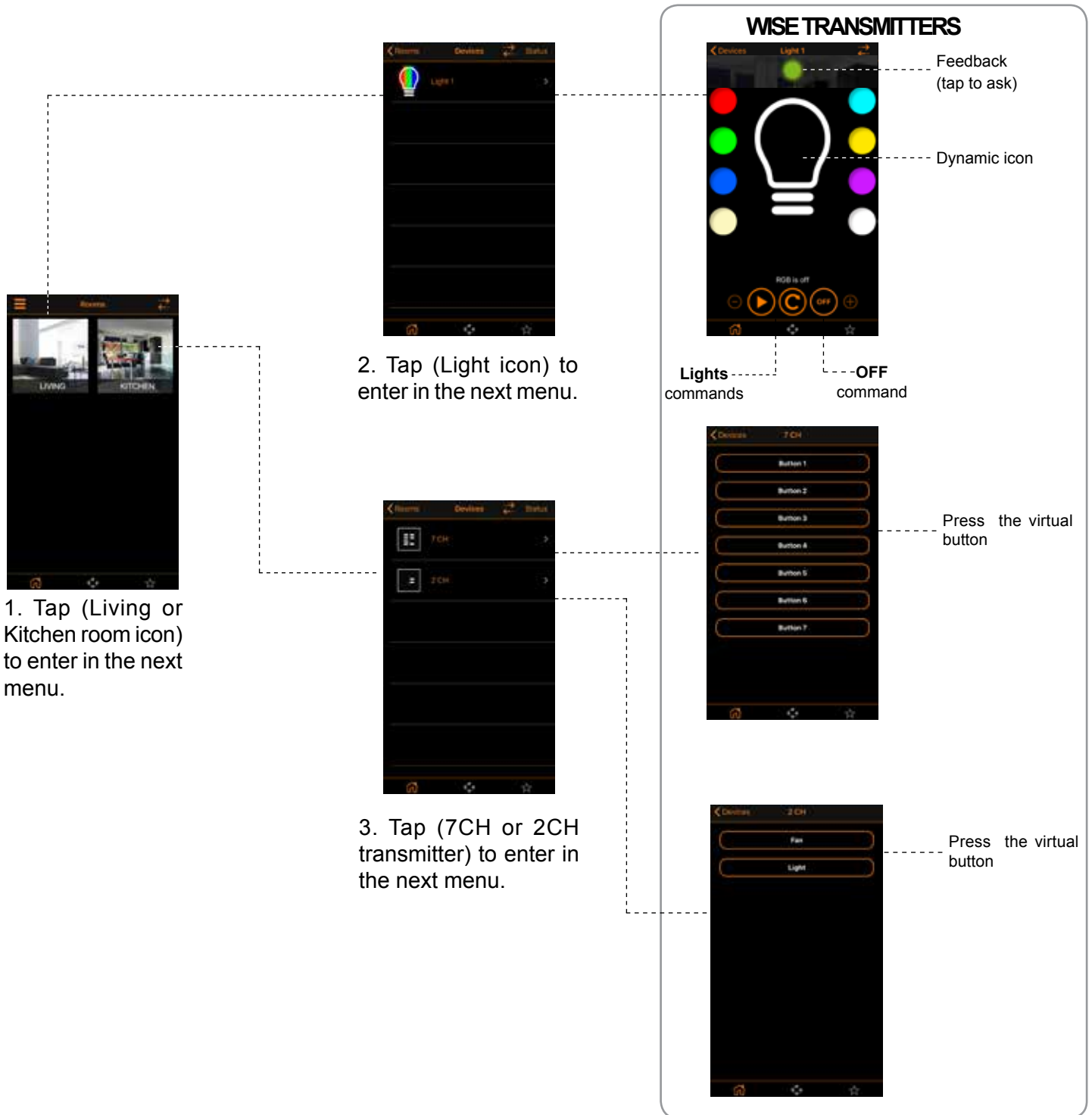

## 14.2 Memorization



Wise transmitter

For its proper functioning the **Wise transmitter** must be memorized in the controlled receiver. Refer to instruction manual of the receiver for the procedure of memorization.



## 14.3 Remote memorization of other radio codes from standard transmitter

**Note:** The button P3 is located inside the standard transmitter. The added radio code will have the same functions as the code used for memorization. This procedure is compatible with any type of transmitter.

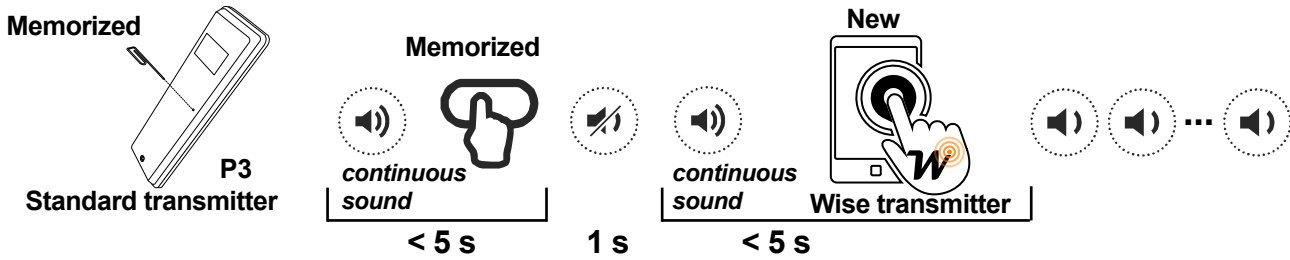

Press button **P3** of the **memorized** standard transmitter and hold. The buzzer emits a continuous sound. Press a button relative to an **already memorized** code. The buzzer stops for 1 second and then starts the continuous sound again. Press the virtual button on the **Wise transmitter** relative to the **new** code to be memorized. Successful memorization is indicated by the intermittent sound of the buzzer.

## 15.0 Sending Scenario



1. Tap (Scenario icon) to enter in the next menu.

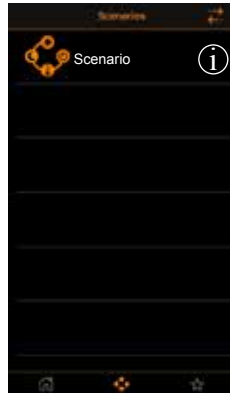

2. Tap (Scenario icon) to send scenario.

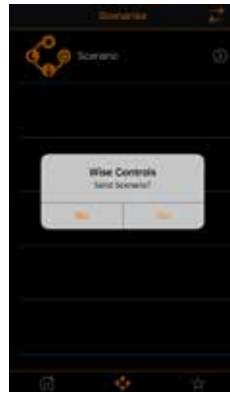

3. Tap (Yes) to send scenario.

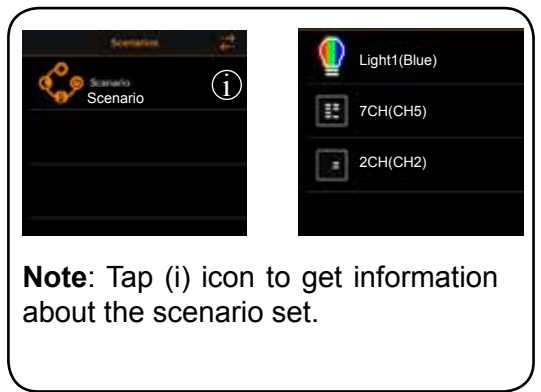

**Note:** Tap (i) icon to get information about the scenario set.

## 16.0 Reset Wi-Fi Network configuration

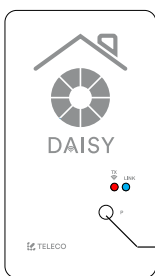

**Button:** Reset Wi-Fi Network configuration (\*)

\* The memorized transmitters are not deleted.

Press **(P)** once and hold for **5s**:

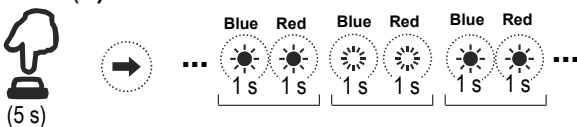

Alternatively **hold the button (P) down** and at the same time **turn on the power**:

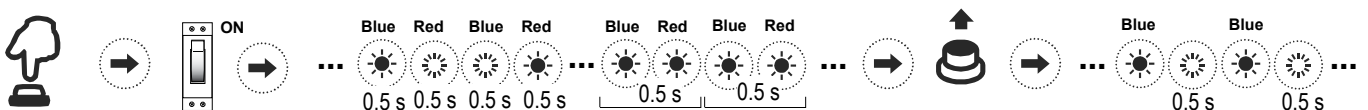

## 17.0 Troubleshooting (what to do IF...)

Problem	Solution
<p><i>First configuration procedure:</i> Blue and Red LEDs flashes alternately for long time</p>	<p>Wait until the LEDs stop flashing even if appear the message "Connection between board and phone failed". If the LEDs continue to flash, check that the router does not have filters blocks set.</p>
<p><i>First configuration procedure:</i> Blue Led flashes slowly - Connection failed</p>	<p>Check that the data are correct and repeat the first installation procedure.</p>
<p><i>First configuration procedure:</i> GPS connection problem</p>	<p>Verify that the GPS function is enabled and set to high precision mode</p>
<p><i>Normal operating mode:</i> Disconnection from the WiFi network: Blue and Red LEDs flashes alternately</p>	<p>Verify that the router is powered and connected to internet.</p>
<p><i>Normal operating mode:</i> No internet connection - Blue LED flashes each 0.3s.</p>	<p>Check the router's internet connection</p>
<p><i>Normal operating mode:</i> Emergency mode - Blue LED flashes each 0.1s.</p>	<p>Available only direct commands. Check the router's internet connection</p>



**WISE APP**

### DAISY BOX

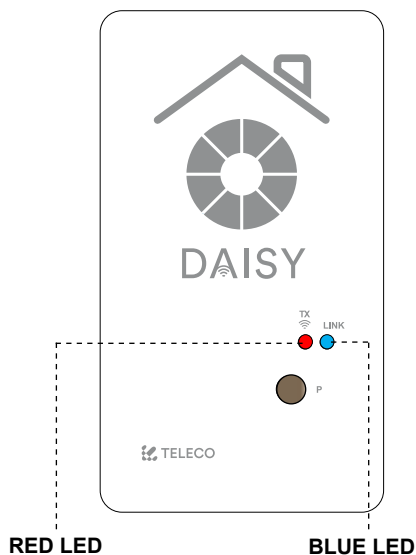



**IMPORTANT! READ CAREFULLY THESE INSTRUCTIONS BEFORE INSTALLING AND COMMISSIONING THE PRODUCT. SAVE THESE INSTRUCTIONS FOR FUTURE REFERENCE.**

**PRODUCT INSTALLATION:** The product at issue must be installed, commissioned and maintained only by licensed and authorised people, respecting the laws concerning the electrical installations. The manufacturer is not responsible for any damage due to wrong installation or improper use.

**SAFETY INFORMATION:** The radio signal reception of the device could be disturbed by the presence of electrical disturbances being transmitted by other appliances working on the same frequency or if the product is somehow shielded by metal parts.

The manufacturer, Teleco Automation s.r.l, declares that the type of radio equipment is compliant with Directive 2014/53/EU. The full text of the EU compliance declaration is available at the following Internet address: [www.telecoautomation.com/ce](http://www.telecoautomation.com/ce).

**In the view of a constant development of their products, the manufacturer reserves the right for changing technical data and features without prior notice.**

**INFORMATION TO USERS** under art. 14 of the 2012/19/EU DIRECTIVE OF THE EUROPEAN PARLIAMENT AND COUNCIL of 4 July 2012 on waste electrical and electronic equipment (WEEE). The crossed bin symbol on the equipment, or its packaging, indicates that the product must be collected separately from other waste at the end of its useful life and not with mixed urban waste. Please contact your municipality, or local authority, for all information regarding the waste sorting systems available in the area. The retailer is obliged to collect the old equipment free-of-charge when the customer buys a new equivalent equipment. This is to encourage correct recycling/disposal. Appropriate waste sorting for the subsequent recycling, treatment and disposal in an environmentally sound way of the disused equipment avoids negative effects on the environment or human health and favours the re-use or recycling of the equipment's materials.

